

May 2000
Vol. 25
No. 5

U.S. \$4
CAN \$5

JEMS

JOURNAL OF EMERGENCY MEDICAL SERVICES

AMIODARONE Hits the Streets

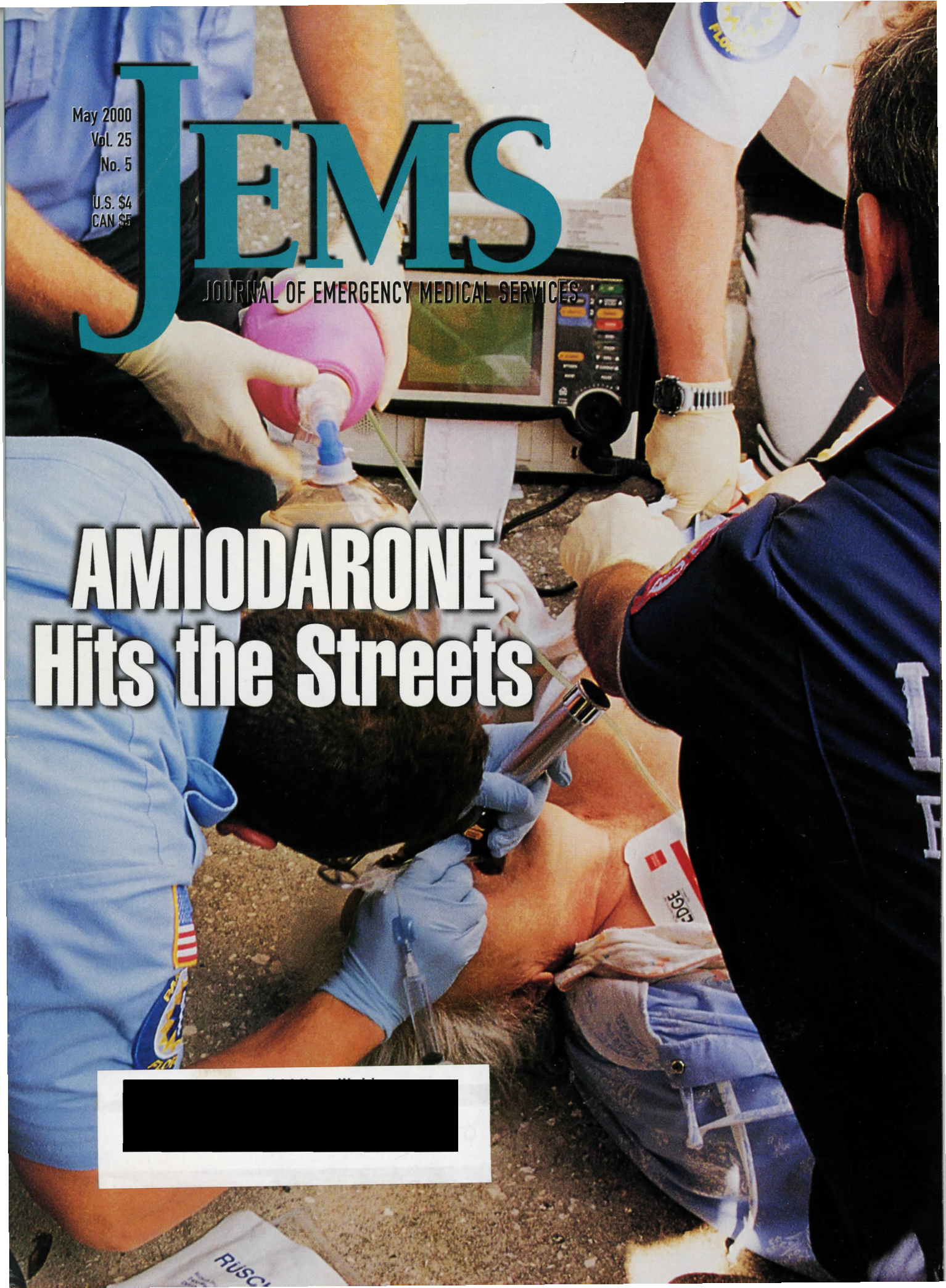
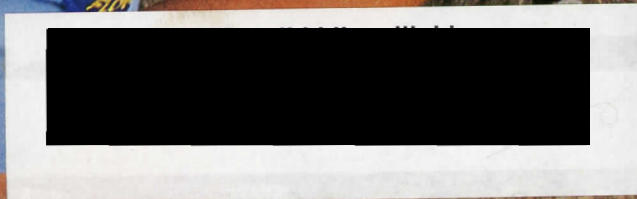

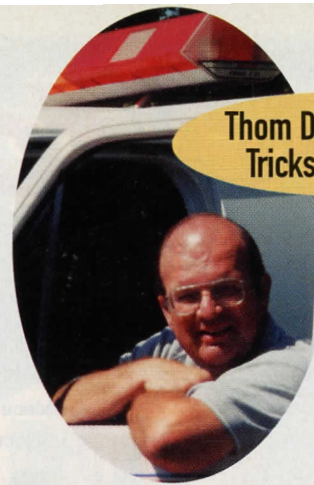

Thom Dick returns to Tricks of the Trade

93

CONTENTS

Features

28 20 Respiratory Challenges
Use training, technology & common sense to conquer respiratory problems
By Gregory R. Frailey, DO, FACOEP

36 Heart Failure & Pulmonary Edema
Understanding & correcting problems with the body's amazing pump
By Connie J. Mattera, MS, RN

48 Tube Test
Use the syringe aspiration technique to recognize esophageal intubations
By Kenneth J. Sternig, BSN, EMT-P, Ronald G. Pirrallo, MD, MHSA, Connie Mc Keag, RRT, EMT-P, & Del Szewczuga, RN, EMT-P

60 An Old Drug with New Tricks
Amiodarone hits the streets
By Ronny Taylor, LIC-P, & Edward Racht, MD

76 The Pressure Is On
Hyperbaric oxygen treatment as an adjunct to prehospital care
By Gregg S. Margolis, MS, NREMT-P, Ronald N. Roth, MD, FACEP, & Kevin R. Hardy, MD

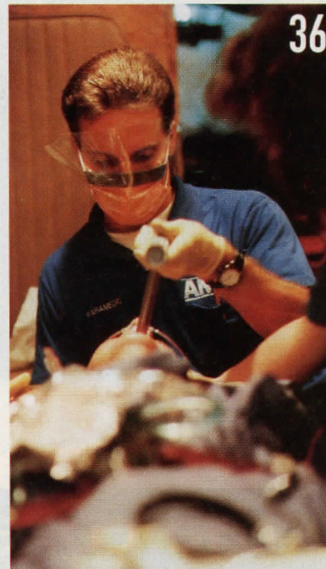
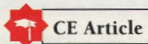

36

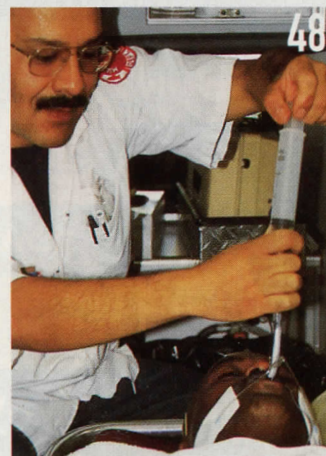

48

Columns

9 From the Editor
Conquering Medical Tradition
By A.J. Heightman

22 Case of the Month
Beware of Patients under the Influence
By Paul A. Werfel

105 Ask Sirenhead
Patient Security Redefined

Departments

12 Letters

16 EMS News

20 Canadian News

25 Research Review

90 Ad Index

93 Hands On

97 Classifieds

106 Last Word

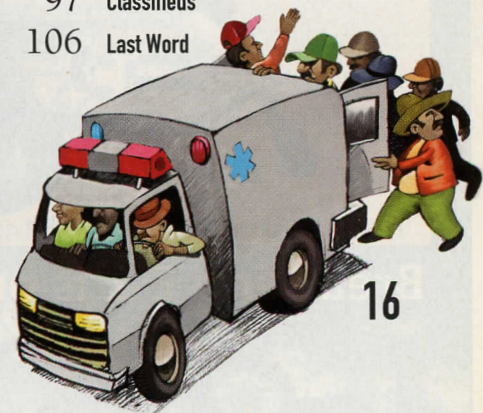

16

60

Cordarone (amiodarone HCl) **1A**
150 MG/3 ML
(50 MG/ML)
MUST BE DILUTED FOR I.V. USE ONLY
CAUTION: FEDERAL LAW PROHIBITS DISPENSING



About the cover: Paramedics from Largo (Fla.) Fire Department and Sunstar Ambulance, Largo, Fla., work to resuscitate a patient in cardiac arrest. The woman, in her late 70s, walked outside her family's home and collapsed.

PHOTO EDDIE SPERLING

Life/form[®]

Auscultation Trainer

- Hear Different Heart and Lung Sounds as the Smartscope is Moved to Various Locations on the Manikin
- Palpable Landmarks
- Invisible Auscultation Sites
- Menu of Heart and Lung Conditions
- Select Conditions by Remote Control

Contact us for more information and your FREE Health Care Educational Materials catalog.

Nasco

1-800-558-9595

P.O. Box 901, Fort Atkinson, WI 53538-0901

P.O. Box 3837, Modesto, CA 95352-3837

Order on-line: www.eNASCO.com

E-mail: lifeform@eNASCO.com

RP005

For More Information Circle #13 On Reader Service Card

JEMS

JOURNAL OF EMERGENCY MEDICAL SERVICES

PUBLISHER: James O. Page
PUBLISHER/GENERAL MANAGER: Jeff Berend

EDITORIAL DIRECTOR: Lisa Dionne
EDITOR: A.J. Heightman
MANAGING EDITOR: Michelle Garrido
ASSOCIATE EDITOR: Keri Losavio
MEDICAL EDITOR: Edward T. Dickinson, MD, FACEP
CONTRIBUTING NEWS WRITER: Marion Angell Garza
TECHNICAL EDITOR: Richard Vance, EMT-P
EDITORIAL SECRETARY: Laurie Colvin
FOUNDING EDITOR: Keith Griffiths
EDITORIAL FAX: 760/930-9567

ART DIRECTOR: Liliana Cartelli

PRODUCTION COORDINATOR: Tim Francis
GRAPHICS SPECIALIST: Lori D. Biewen
PRODUCTION ASSISTANT: Lisa M. Griffiths
GRAPHICS ASSISTANT: Jason Pelc

ACCOUNT MANAGER: Lisa Tucker, EMT
SALES COORDINATOR: Robin Joseph
ADVERTISING FAX: 760/431-8194

PUBLISHER'S SALES REPRESENTATIVE
Warren Kaufman 818/880-4252

FULFILLMENT MANAGER: Kevin Flanagan
FULFILLMENT ASSISTANT: Tanja Birden

SR. MARKETING MANAGER: Debbie Murray
PRODUCT PROMOTIONS MANAGER: Christina Fürstenberg
MANUFACTURING/WEB COORDINATOR: Janene Long-Forman
TELEMARKETING REPRESENTATIVE: Diane Lewis

ADMINISTRATION MANAGER: Debbie Miller
SR. CREDIT MANAGER: Kathie Fritsch
A/R ASSISTANT: Lori Taylor
MAILROOM CLERK: Tine Williams
IS COORDINATOR: Arron Morgan

DIRECTOR OF CONFERENCES: Denny Hare
MEETING PLANNER: Lisa Taucher, CMP
EXHIBITS MANAGER: Wanda Martin, EMT
EXHIBIT SALES REPRESENTATIVE: Tiffany Freeman
ASSISTANT MEETING PLANNER: Beverly D. Smith
REGISTRATION COORDINATOR: Candy Hixson
CUSTOMER SERVICE REPRESENTATIVE: Christy Freeman

CONTRIBUTING EDITORS: Robert Ball, EMT-P, Dwayne Clayden, EMT-P, Bryan E. Bledsoe, DO, EMT-P, Scott Bourn, RN, EMT-P, Garry Briese, CAE, Norm Dinerman, MD, Gregory R. Frailey, D.O., EMT-P, Mike Frank, MD, Marion Angell Garza, Keith Griffiths, Pamela Leis Higdon, William J. Koenig, MD, Loren Marshall, EMT-P, Jack K. McElfish, Gary Morris, Mary Newman, William Roush, MD, Paul Werfel, NREMT-P

CONTRIBUTING PHOTOGRAPHERS: Peter Escobedo, Craig Jackson, Mark Ide, Ken Kerr, Tom Page, Howard M. Paul

CONTRIBUTING CARTOONIST: Steve Berry, NREMT-P

WORLD WIDE WEB ADDRESS: www.jems.com
MAIN PHONE: 760/431-9797; MAIN FAX: 760/431-8176

POSTMASTER: Send address changes to JEMS, Journal of Emergency Medical Services, P.O. Box 469010, Escondido, CA 92046. Claims of nonreceipt or damaged issues must be filed within three months of cover date. Periodicals postage paid at Carlsbad, Calif., and at additional mailing offices. Canada Post International Publications Mail Product (Canadian Distribution) Sales Agreement No 1247948.

JEMS, Journal of Emergency Medical Services, (ISSN 0197-2510), is published monthly by Jems Communications, 1947 Camino Vida Roble, Suite 200, Carlsbad, CA 92008; 760/431-9797 (fed. ID #43-0891713). **Subscription information:** Send \$27.97 for one year (12 issues), \$50.97 for two years (24 issues) or \$68.97 for three years (36 issues) to P.O. Box 469010, Escondido, CA 92046. Canada—please add \$18 per year for postage. All other foreign subscriptions, please add \$20 per year for surface and \$70 per year for airmail postage. For new orders only, call toll-free 888/456-5367. **Advertising information:** Rates are available on request. Contact JEMS advertising department at 1947 Camino Vida Roble, Suite 200, Carlsbad, CA 92008; P.O. Box 2789, Carlsbad, CA 92018; 760/431-9797.

Editorial information: Manuscripts and queries should be directed to JEMS Editor, P.O. Box 2789, Carlsbad, CA 92018. Editorial guidelines are available on request. Submitted manuscripts should be typed, double-spaced and submitted in quadruplicate. **Microfiche:** JEMS is available on microfiche. Please direct inquiries to University Microfilms International, 300 N. Zeeb Road, Ann Arbor, MI 48106; 800/521-3044. **Copyright 2000** Jems Communications. No material may be reproduced or uploaded on computer network services without the expressed permission of the publisher.

JEMS is indexed in the Cumulative Index to Nursing & Allied Health Literature.

SUBSCRIPTION INFORMATION: 888/456-5367
JEMS is printed in the United States.



JEMS
COMMUNICATIONS
A Harcourt Health Sciences Company

Innovative to the core.

E-Z Click **BRASS** Oxygen Regulators from American Healthcare

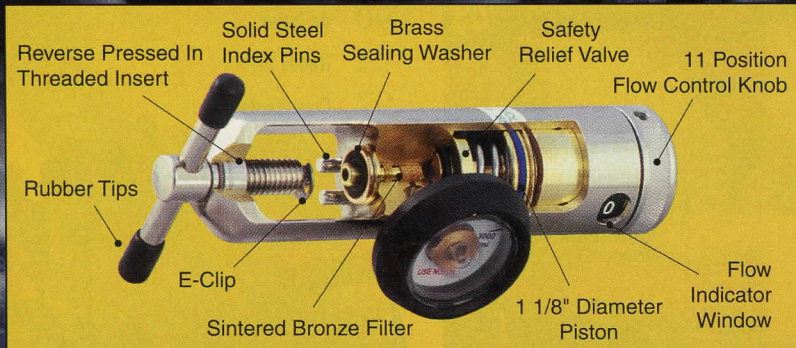

Breathing E-Z is only a click away.

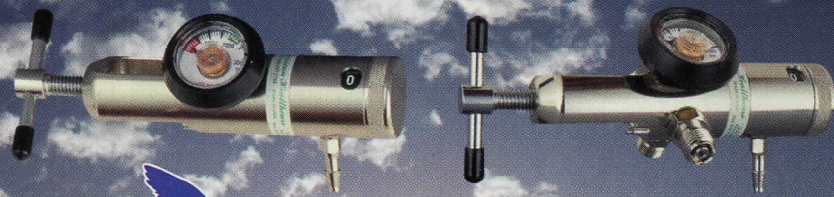

American
Healthcare

TOLL FREE 1.888.567.7733
www.americanhealthcareinc.com
PO Box 540 West Buxton, ME 04093

For More Information Circle #14 On Reader Service Card